

## Product Datasheet - WSL 6050F1 Series - Single Doors

The Wrightstyle 6050F1 series range of glazing systems provides an unlimited number of fenestration options. Utilising a range of high quality steel profile shapes it provides countless possibilities for fire insulated applications.

Multiple configurations of doors, screens and windows can be produced from Wrightstyle's vast range of profiles; an integral part of Wrightstyle's total glazing system solutions.

Profiles are produced from cold rolled hollow sections, manufactured to strict production tolerances from 2mm steel, punched and filled with a unique infilling material to provide an enhanced thermal barrier.

Modern manufacturing processes allow us to produce steel glazing systems, which combine the inherent strength and durability of steel, with the aesthetic qualities normally associated with aluminium systems. The following pages provide a brief overview of the capabilities of the systems.

- Competitively priced
- Multiple framing options
- High quality sendzimir galvanising
- Internal & external surface protection
- 2mm steel thickness
- Tested to 60 minutes fire rating
- Multiple hardware options
- Multiple tape or gasket glazing options
- Fully enclosed profile design for ease of fabrication and superior flat finish
- Can be supplied in bar length, semi-prepared kit form or fully fabricated

### WSL 6050F1 Series - Door Configuration (colours shown for clarity)

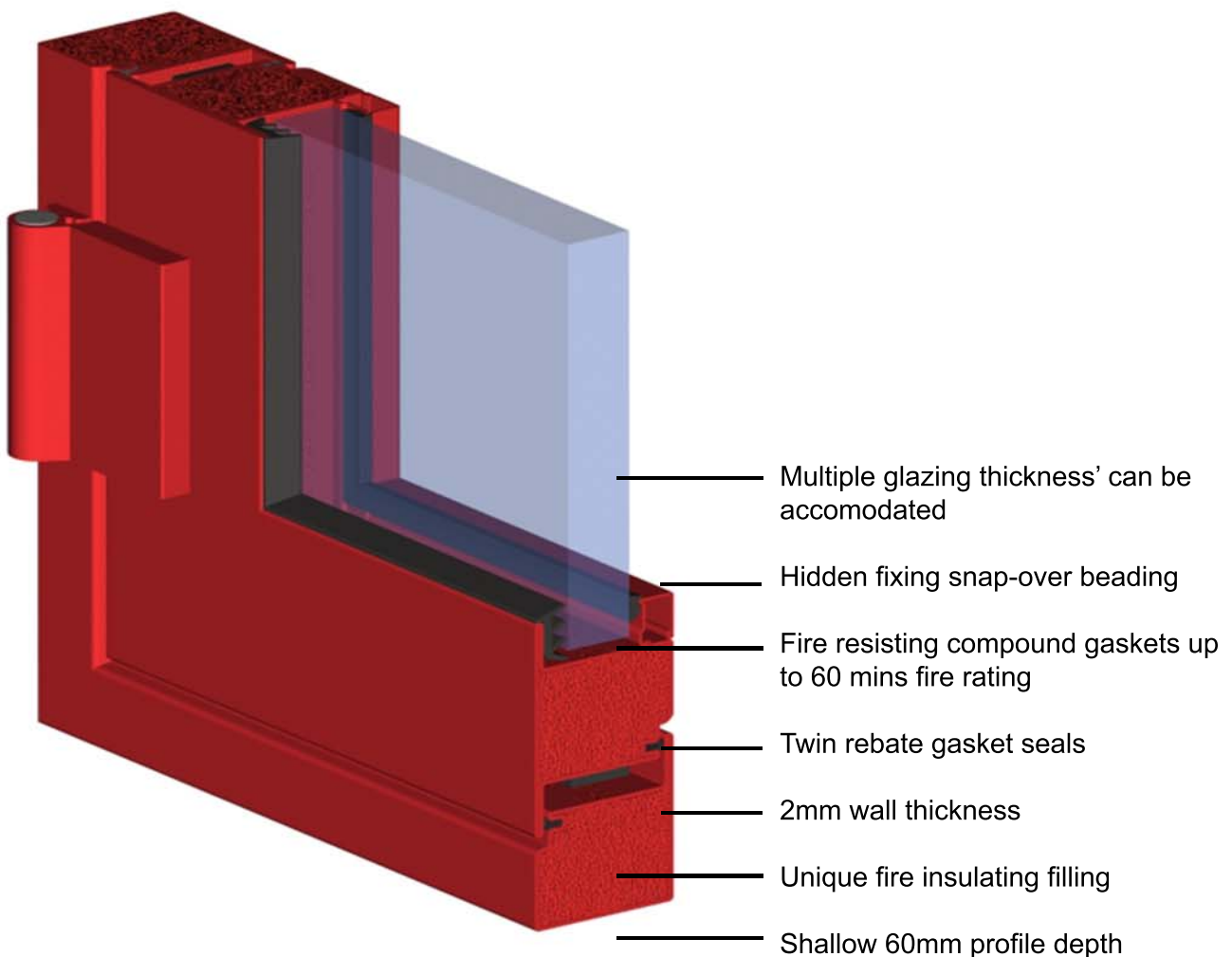

## Product Datasheet - WSL 6050F1 Series - Single Doors

RHR - Open Out

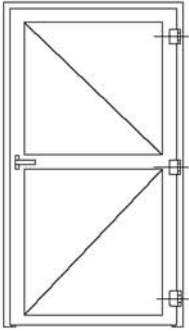

LHR - Open Out

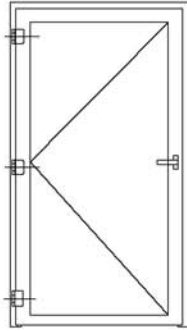

LH - Open In

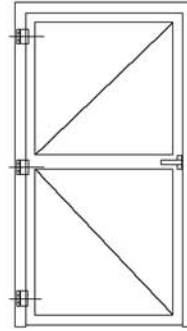

RH - Open In

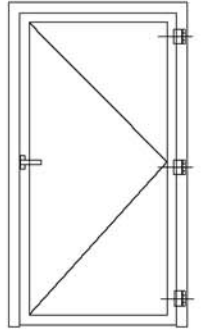

### WSL 6050F1 series door permissible dimensions 30 mins integrity and insulation

Type:	Maximum Door Height	Maximum Door Width	Fire Rating
WSL 6050F1 Series door single point latch	2750mm clear passage	1500mm clear passage	30 mins integrity & insulation
WSL 6050F1 Series door two point latch	3175mm clear passage	1500mm clear passage	30 mins integrity & insulation

#### Directions:

Plot your required door size on the chart below. Current test data allows for any clear passage size within the red & green areas.

If the door size falls within the red area then the door can have a single-point latch.

If the door size falls partly within the green area then the door must have a minimum of a two-point latch.

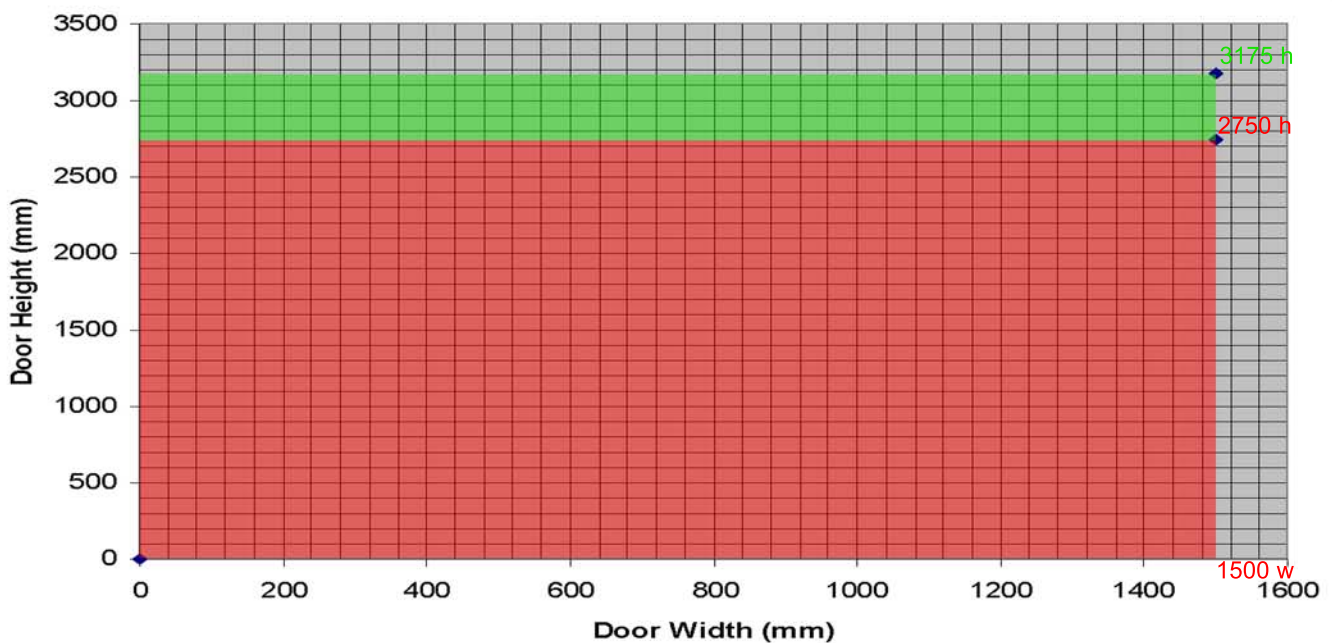

Note: Additional conditions may apply. Please check test data

## Product Datasheet - WSL 6050F1 Series - Single Doors

### WSL 6050F1 series door permissible dimensions 60 mins integrity and insulation

Type:	Maximum Door Height	Maximum Door Width	Fire Rating
WSL 6050F1 Series door single point latch	2500mm clear passage	1380mm clear passage	60 Mins integrity and insulation
WSL 6050F1 Series door two point latch	2640mm clear passage	1400mm clear passage	60 Mins integrity and insulation

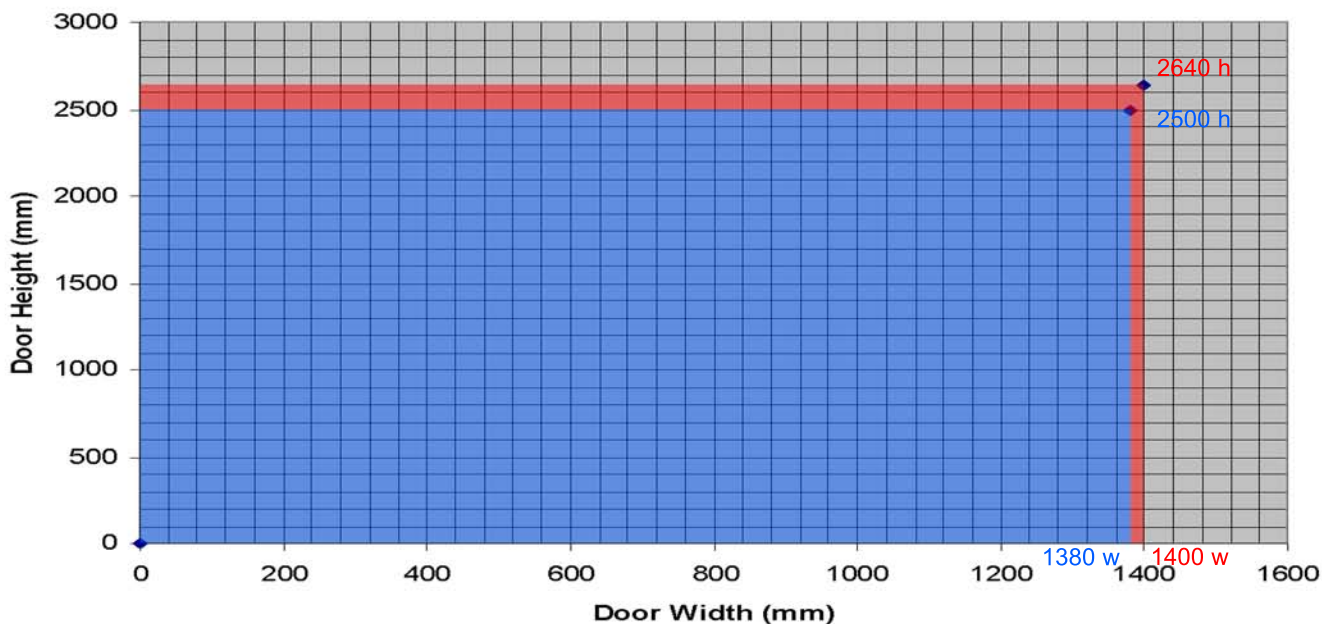

### WSL 6050F1 series door permissible dimensions 90 mins integrity, 30 mins insulation

Type:	Maximum Door Height	Maximum Door Width	Fire Rating
WSL 6050F1 Series door single point latch	2366mm clear passage	1075mm clear passage	90 Mins integrity 30mins insulation

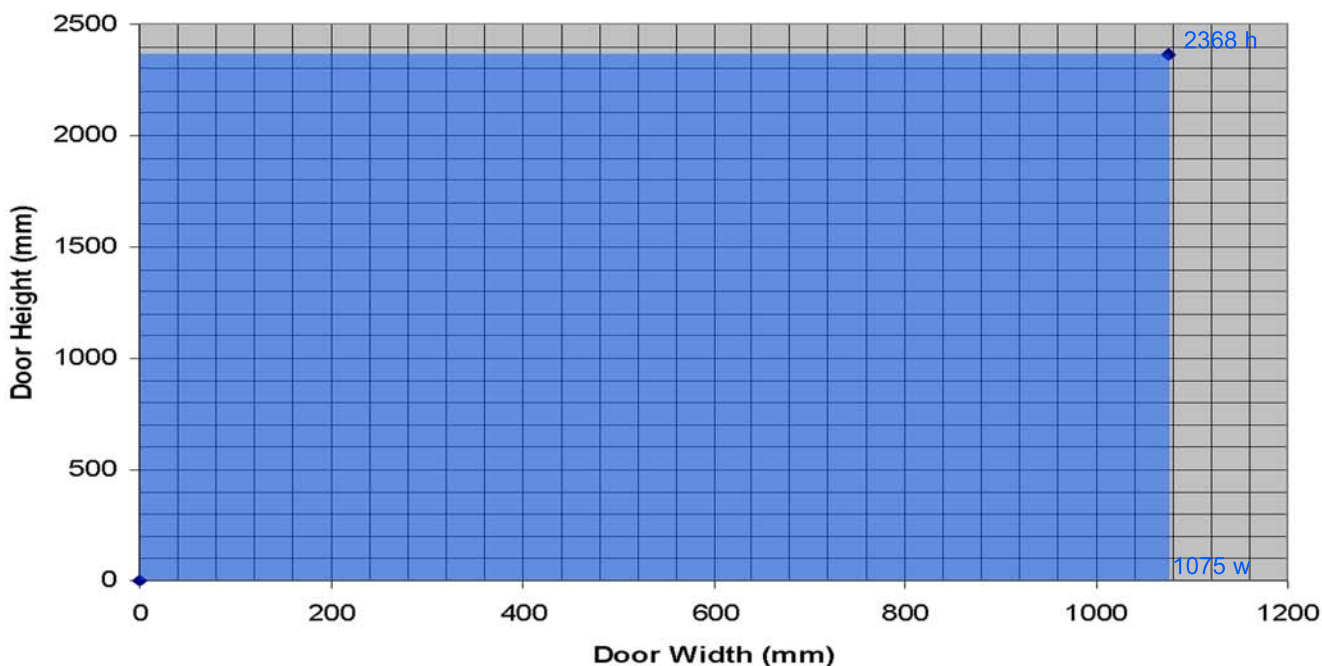

Note: Additional conditions may apply. Please check test data