

Product Datasheet - WSL 5050 Series - Double Doors

The Wrightstyle 5050 series range of glazing systems provides an unlimited number of fenestration options. Utilising a wide range of high quality steel and stainless steel profile shapes, it provides countless possibilities.

Multiple configurations of doors, screens and windows can be produced from Wrightstyle's vast range of profiles; an integral part of Wrightstyle's total glazing system solutions.

Profiles are produced from cold rolled pre-galvanised strip, manufactured to strict production tolerances from 2mm steel.

Modern manufacturing processes allow us to produce steel glazing systems, which combine the inherent strength and durability of steel, with the aesthetic qualities normally associated with aluminium systems. The following pages provide a brief overview of the capabilities of the systems.

- Competitively priced
- Multiple fenestration options
- High quality sendzimir galvanising
- Internal & external surface protection
- 2mm steel thickness
- Tested to 3 hours fire rating
- Multiple hardware options
- Multiple tape or gasket glazing options
- Can be supplied in bar length, semi-prepared kit form, or fully fabricated

WSL 5050 Series - Door Configuration (colours shown for clarity)

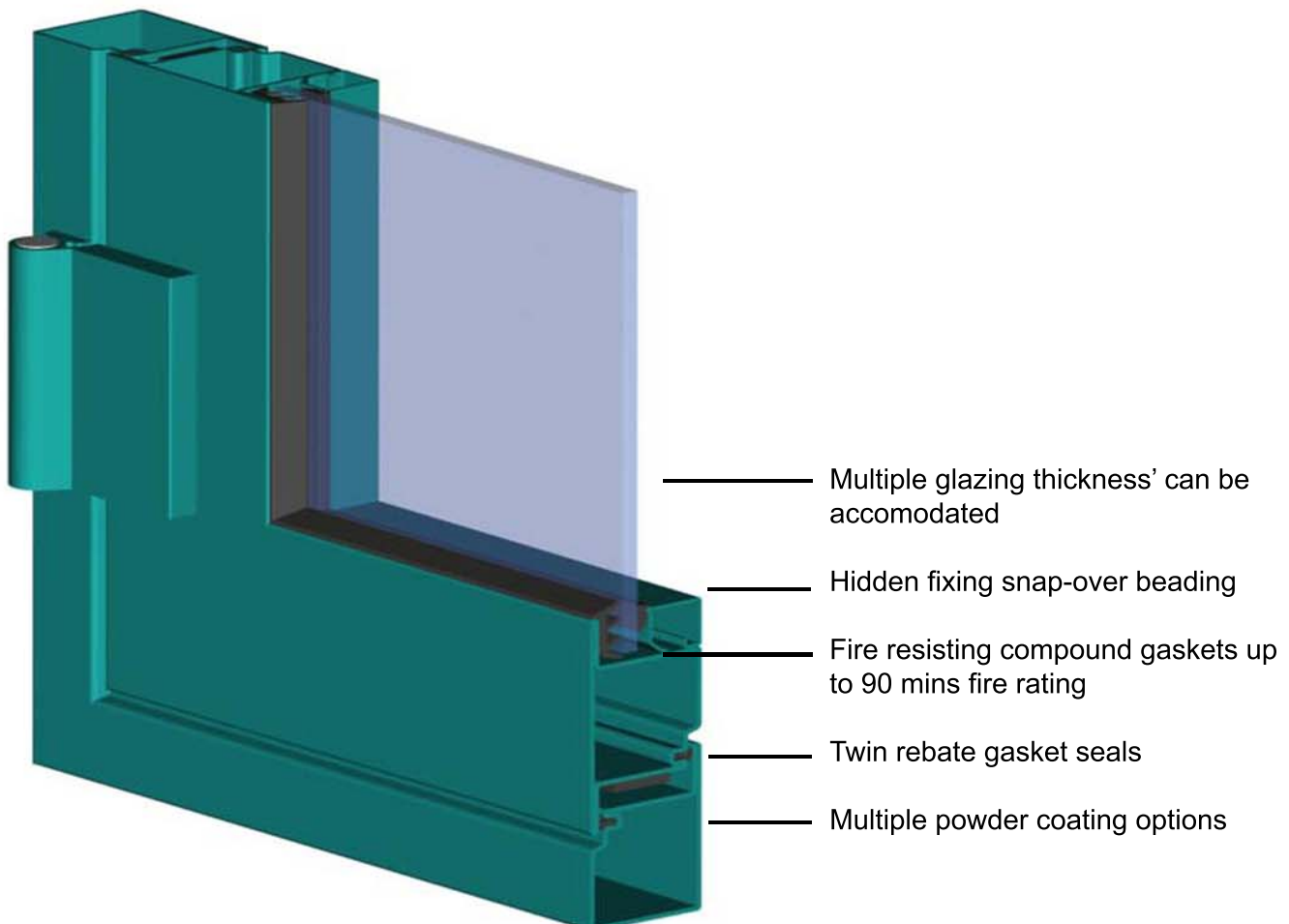

Product Datasheet - WSL 5050 Series - Double Doors

DRHR Open Out
Active Leaf - Right

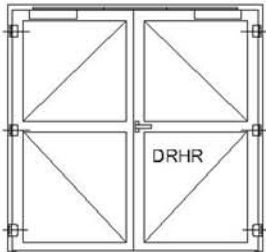

DLHR Open Out
Active Leaf - Left

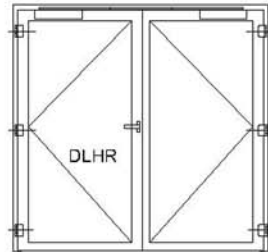

DLH Open In
Active Leaf - Left

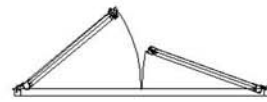
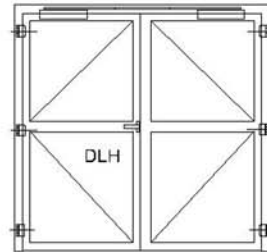

DRH Open In
Active Leaf - Right

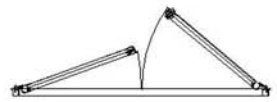
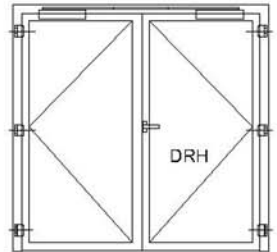

WSL 5050 series door permissible dimensions 30 mins integrity only

Type:	Maximum Door Height	Maximum Door Width	Fire Rating
WSL 5050 Series doors single point latch to active leaf, shoot bolts to inactive leaf.	2500mm clear passage	2300mm clear passage	30 Mins integrity only
WSL 5050 Series doors two point latch to active leaf, nothing to inactive leaf.	2630mm clear passage	2630mm clear passage	30 Mins integrity only
WSL 5050 Series doors two point latch to active leaf, shoot bolts to inactive leaf.	2630mm clear passage	2630mm clear passage	30 Mins integrity only

Directions:

Plot your required door size on the chart below. Current test data allows for any clear passage size within the red & blue areas.
 If the door size falls completely within the blue area then the doors may be installed with single point latch to active leaf and shoot bolts installed to inactive leaf.
 If the door size falls partly within the red area then the doors must be installed with two-point latch to active leaf and either shoot bolts or nothing installed to the inactive leaf..

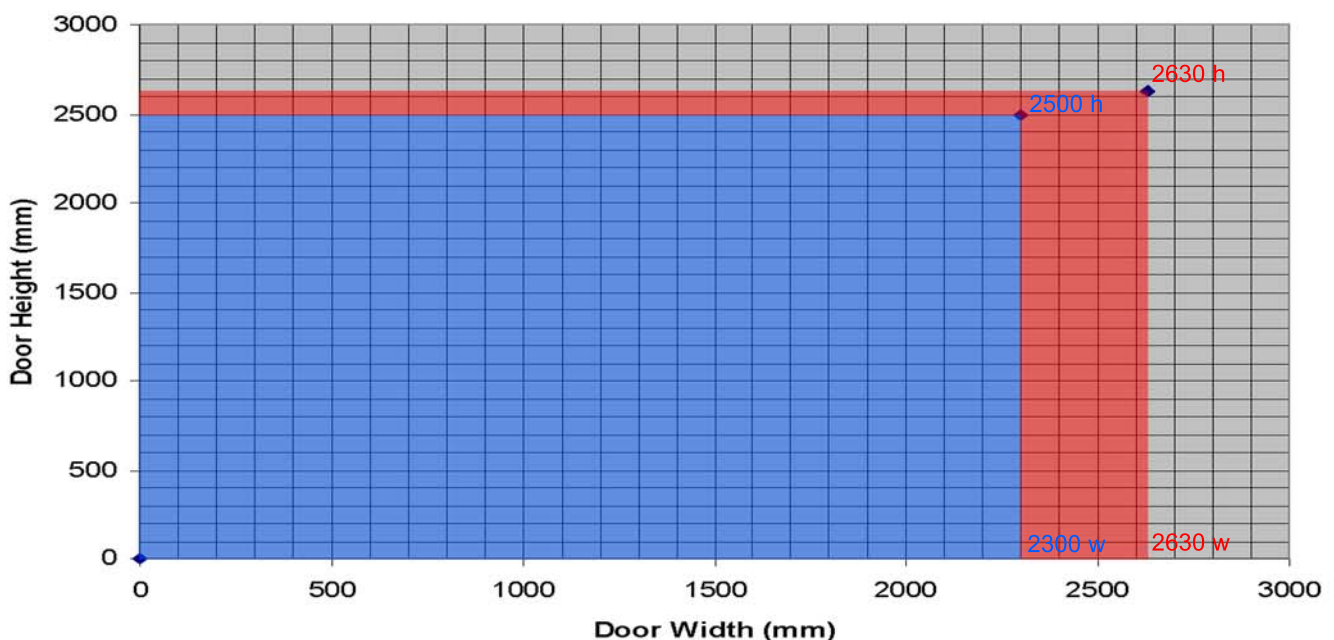

Note: Additional conditions may apply. Please check test data

Product Datasheet - WSL 5050 Series - Double Doors

WSL 5050 series door permissible dimensions 60 mins integrity only

Type:	Maximum Door Height	Maximum Door Width	Fire Rating
WSL 5050 Series doors single point latch to active leaf, shoot bolts to inactive leaf.	2300mm clear passage	2100mm clear passage	60 Mins integrity only
WSL 5050 Series doors two point latch to active leaf, nothing to inactive leaf.	2400mm clear passage	2400mm clear passage	60 Mins integrity only
WSL 5050 Series doors two point latch to active leaf, shoot bolts to inactive leaf.	2550mm clear passage	2400mm clear passage	60 Mins integrity only

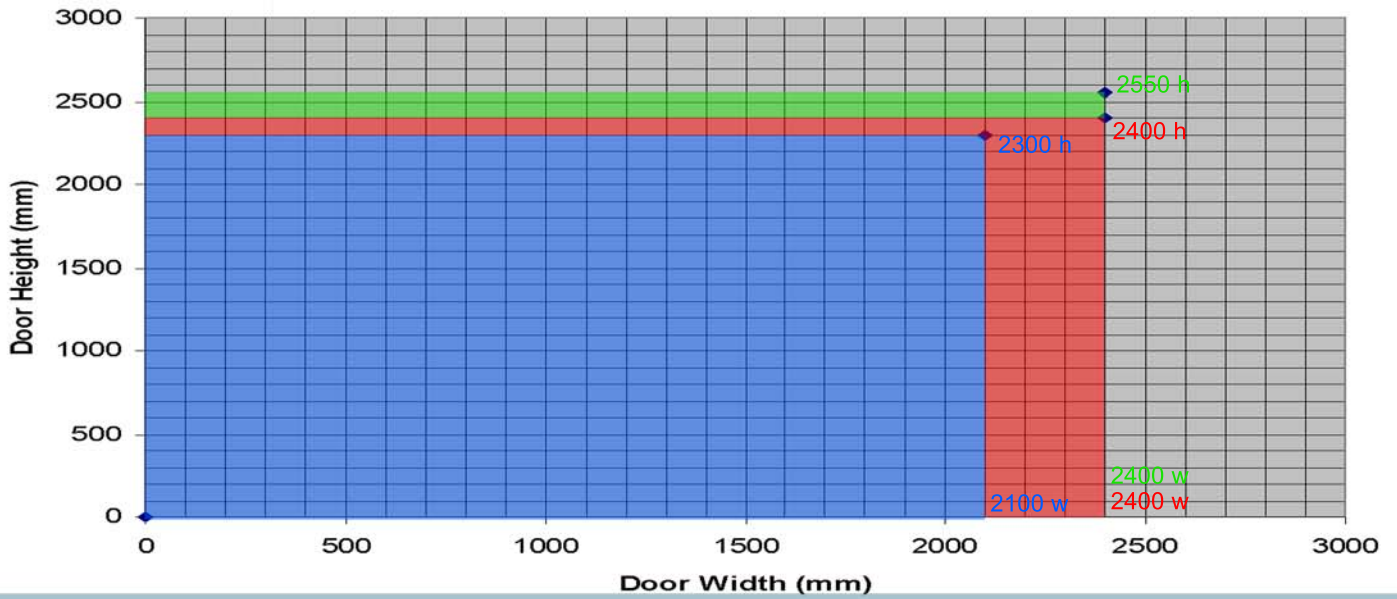

WSL 5050 series door permissible dimensions 90,120 & 180 mins integrity only

Type:	Maximum Door Height	Maximum Door Width	Fire Rating
WSL 5050 Series doors two point latch to active leaf, shoot bolts to inactive leaf.	2450mm clear passage	2025mm clear passage	90 Mins integrity only
WSL 5050 Series doors two point latch to active leaf, shoot bolts to inactive leaf.	2450mm clear passage	2025mm clear passage	120 Mins integrity only
WSL 5050 Series doors two point latch to active leaf, shoot bolts to inactive leaf.	2340mm clear passage	1930mm clear passage	180 Mins integrity only

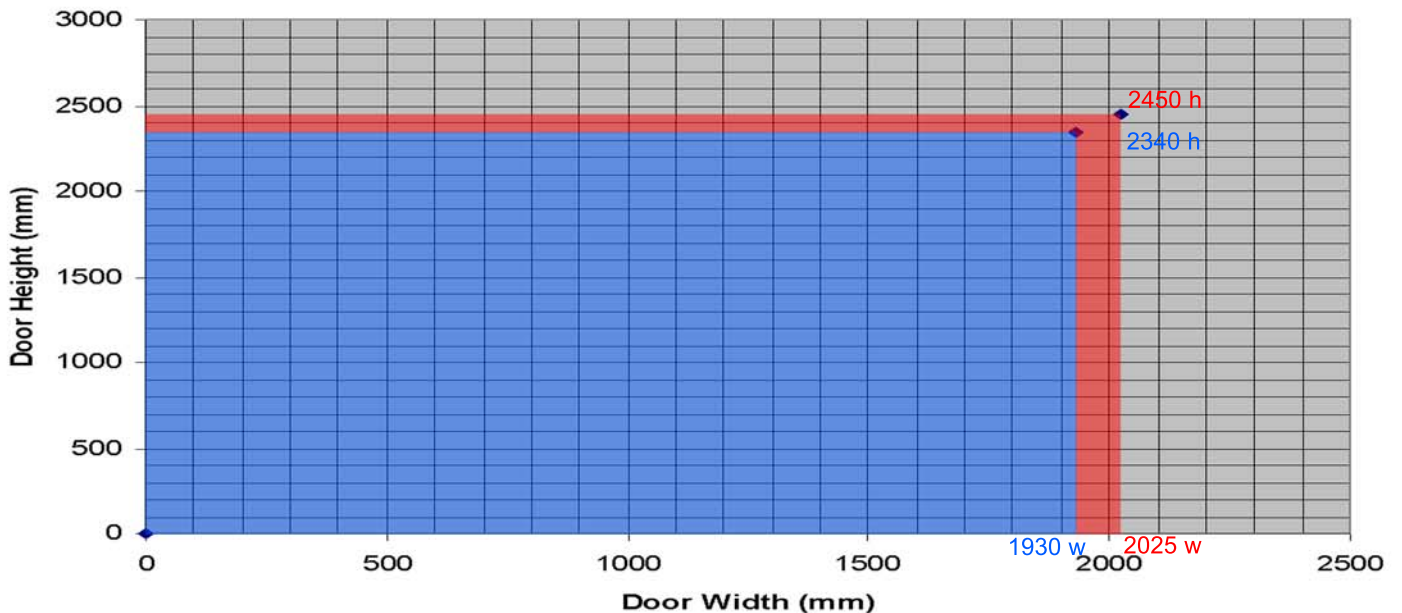

Note: Additional conditions may apply. Please check test data